

TPS6227xEVM-306

The TPS6227xEVM-306 user's guide describes the characteristics, operation, and use of the TPS6227xEVM-306 evaluation module (EVM). This EVM demonstrates the Texas Instruments TPS62270, a 2.25 MHz, synchronous step-down converter that provides up to 400 mA of output current. See the TPS62270 data sheet ([SLVS799](#)), *2.25 MHz 400-mA Step Down Converter With Selectable VOUT* for device specifications and recommended operating conditions. This user's guide includes setup instructions, a schematic diagram, a bill of materials (BOM), and PCB layout drawings for the evaluation module.

Contents

1	Introduction	1
2	Setup	2
3	Operation	2
4	Test Results	3
5	Board Layout	6
6	Schematic and Bill of Materials	8
6.1	Schematic.....	8
6.2	Bill of Materials	9

List of Figures

1	Start up from Enable, $V_I = 3.6\text{ V}$, $V_{OUT} = 1.15\text{ V}$, $R_{Load} = 2.5\ \Omega$	3
2	Load Transient, 115 mA to 300 mA step, $V_I = 3.6\text{ V}$, $V_{OUT} = 1.15\text{ V}$	3
3	Load Transient, 300 mA to 115 mA step, $V_I = 3.6\text{ V}$, $V_{OUT} = 1.15\text{ V}$	4
4	Start up from Enable, $V_I = 3.6\text{ V}$, $V_{OUT} = 0.9\text{ V}$, $R_{Load} = 2.5\ \Omega$	4
5	Load Transient, 90 mA to 272 mA step, $V_I = 3.6\text{ V}$, $V_{OUT} = 0.9\text{ V}$	5
6	Load Transient, 272 mA to 90 mA step, $V_I = 3.6\text{ V}$, $V_{OUT} = 0.9\text{ V}$	5
7	VSEL Output Voltage Response, $V_I = 3.6\text{ V}$, $R_{Load} = 3.3\ \Omega$	6
8	Assembly Layer	7
9	Top Layer Routing	7
10	Bottom Layer Routing	8
11	TPS6227xEVM-306 Schematic.....	8

List of Tables

1	TPS6227xEVM-306 Jumpers and Connections	2
2	TPS6227xEVM-306 Bill of Materials.....	9

1 Introduction

The TPS6227xEVM-306 EVM helps designers evaluate the operation and performance of the TPS62270 DC/DC converter. This converter is a 2.25 MHz, synchronous, step-down converter capable of providing 400 mA of output current.

Related Documentation From Texas Instruments

TPS62270 data sheet ([SLVS799](#)), *2.25 MHz 400-mA Step Down Converter With Selectable VOUT*.

2 Setup

Table 1 describes the jumpers and connectors on the EVM, as well as how to properly connect, setup, and use the TPS6227xEVM-306.

Table 1. TPS6227xEVM-306 Jumpers and Connections

Jumper	Connection Description	Connection Instructions
J1 – VIN	Positive input supply voltage	Leads to the input supply should be twisted and kept as short as possible to minimize EMI transmission.
J2 – GND	Return connection for converter input power supply	
J3 – VOUT	Output positive connection	Connect this pin to the positive input of the load.
J4 – GND	Output return connection	
JP1⁽¹⁾ – ENABLE	This jumper enables or disables the converter.	Connect the shorting jumper between pin 1 and 2 (ENA and the center pin) enables the converter. ⁽²⁾ Connecting the shorting jumper between pin 2 and 3 (the center pin and DIS) disables the converter. This jumper should never be left floating.
JP2 – VSEL	This jumper is a digital input to the TPS62270 to set the output voltage.	Connecting the shorting jumper between pin 1 and 2 (VSEL and H) sets the output voltage to 1.15V. Connecting the shorting jumper between pin 2 and 3 (VSEL and L) sets the output voltage to 0.9V. Pin 2 of JP2 can be driven by an external logic signal or function generator if desired. This jumper should never be left floating.

⁽¹⁾ The center pin for the JP1 jumper was not labeled when the EVM was constructed. The center pin is referenced in this document as "the center pin."

⁽²⁾ See [TPS6227xEVM-306 Schematic](#) and [Figure 8](#) for jumper and pin names.

3 Operation

Connect the positive input power supply to J1. Connect the input power return (ground) to J2. The TPS6227xEVM-306 has an absolute maximum input voltage of 7.0 V. The recommended maximum operating voltage is 6.0 V.

Connect the desired load between J3 and J4. The TPS6227xEVM-306 can supply up to 400 mA of output current.

Configure Jumpers JP1 and JP2 according to [TPS6227xEVM-306 Jumpers and Connections \(Table 1\)](#) and as required for your application.

4 Test Results

This section provides typical performance waveforms (Figure 1 through Figure 7) using the TPS6227XEVM-306 printed circuit board.

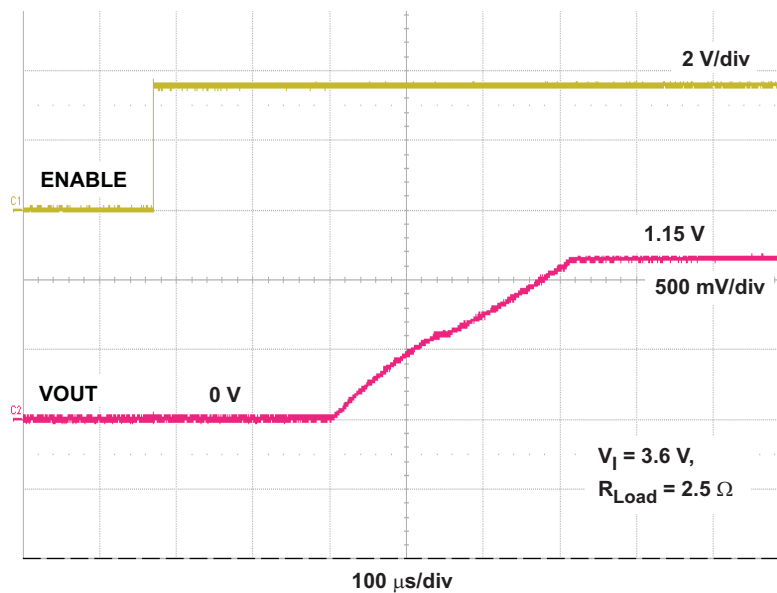

Figure 1. Start up from Enable, $V_I = 3.6\text{ V}$, $V_{OUT} = 1.15\text{ V}$, $R_{Load} = 2.5\ \Omega$

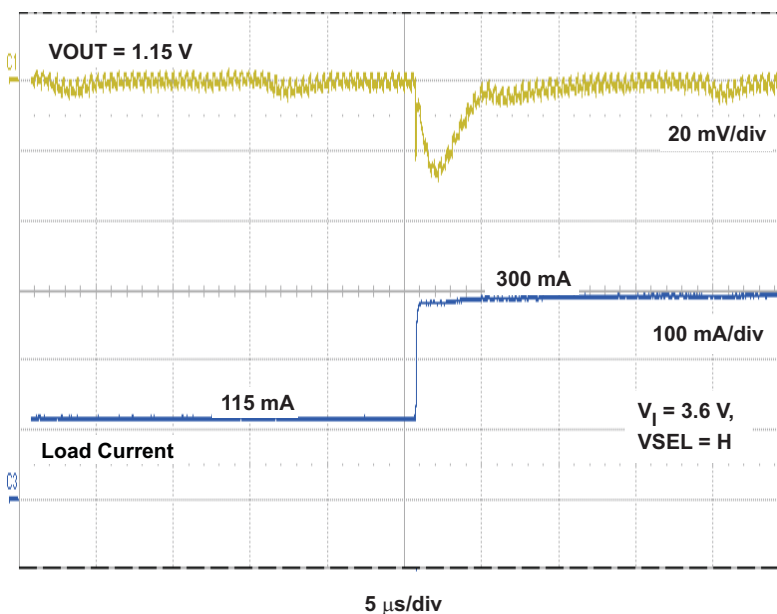

Figure 2. Load Transient, 115 mA to 300 mA step, $V_I = 3.6\text{ V}$, $V_{OUT} = 1.15\text{ V}$

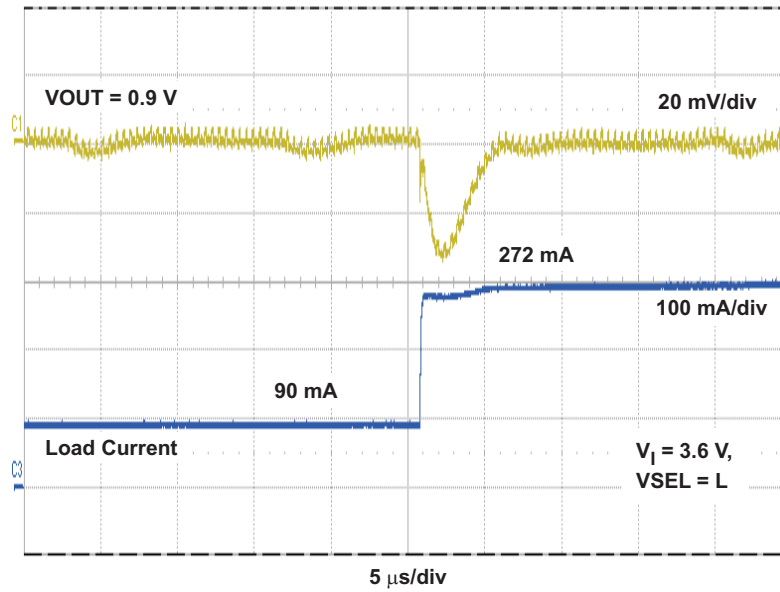

Figure 5. Load Transient, 90 mA to 272 mA step, $V_I = 3.6\text{ V}$, $V_{OUT} = 0.9\text{ V}$

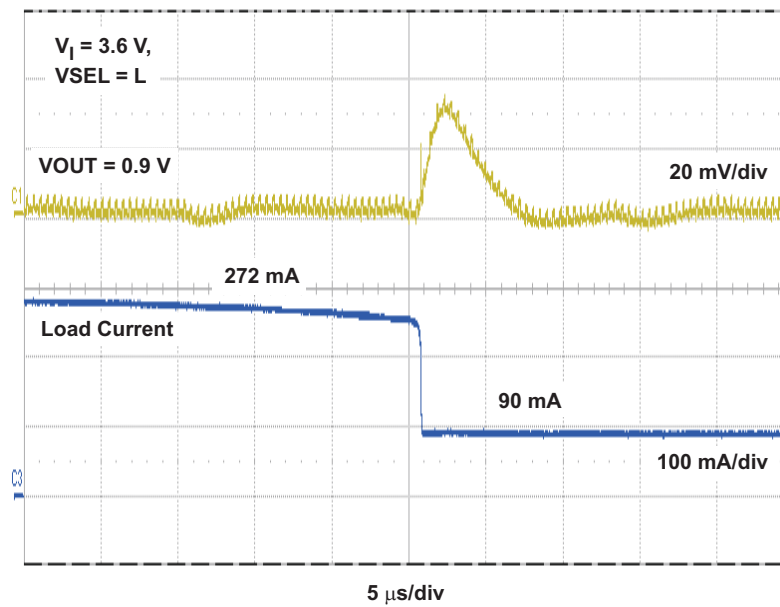

Figure 6. Load Transient, 272 mA to 90 mA step, $V_I = 3.6\text{ V}$, $V_{OUT} = 0.9\text{ V}$

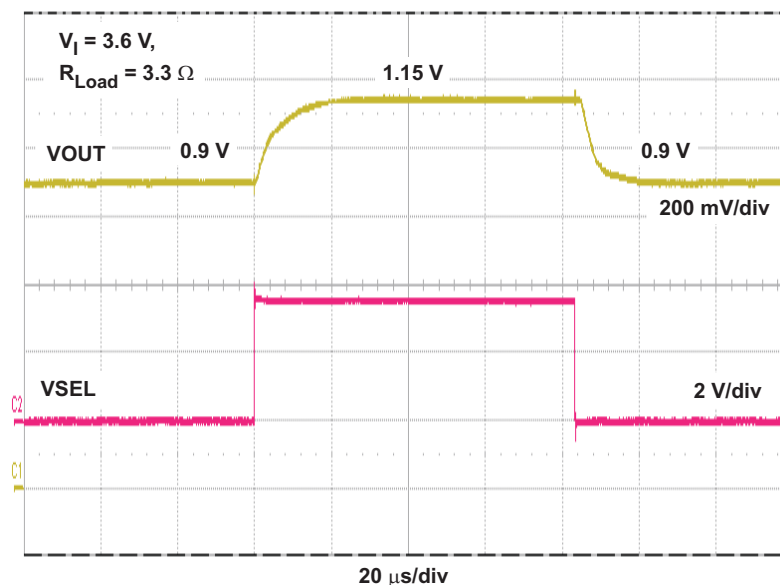

Figure 7. VSEL Output Voltage Response, $V_I = 3.6\text{ V}$, $R_{\text{Load}} = 3.3\ \Omega$

5 Board Layout

This section provides the TPS6227XEVM-306 board layout and illustrations.

Board layout is critical for all high frequency switch mode power supplies. Figure 8 through Figure 10 show the board layout for the TPS6227XEVM-306 printed wire board (PWB). The nodes with high switching frequencies and currents are kept as short as possible to minimize trace inductance. Careful attention has been given to the routing of high frequency current loops and a single point grounding scheme is used. See the TPS62270 data sheet ([SLVS799](#)), *2.25 MHz 400-mA Step Down Converter With Selectable VOUT*, for specific layout guidelines.

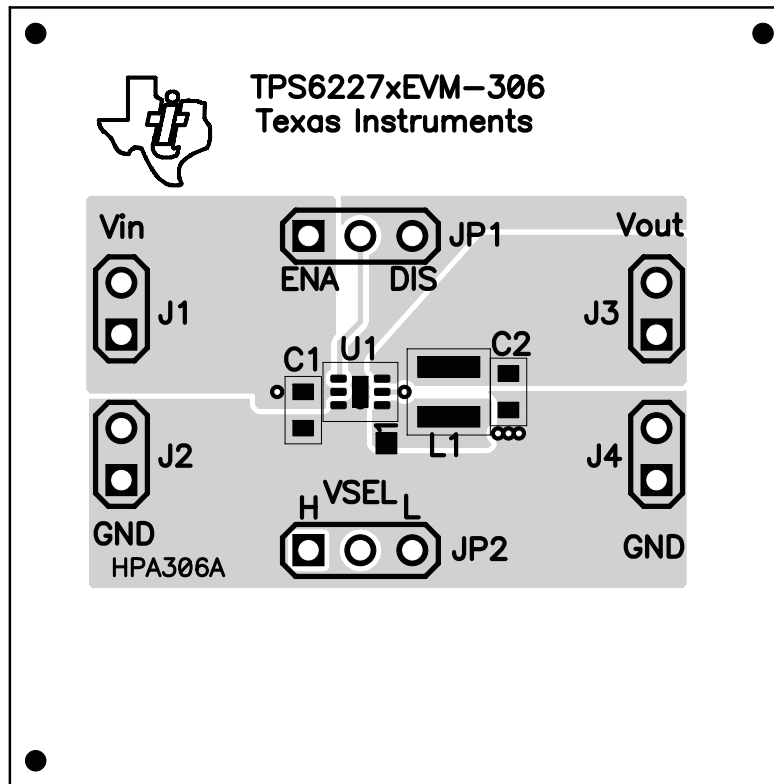

Figure 8. Assembly Layer

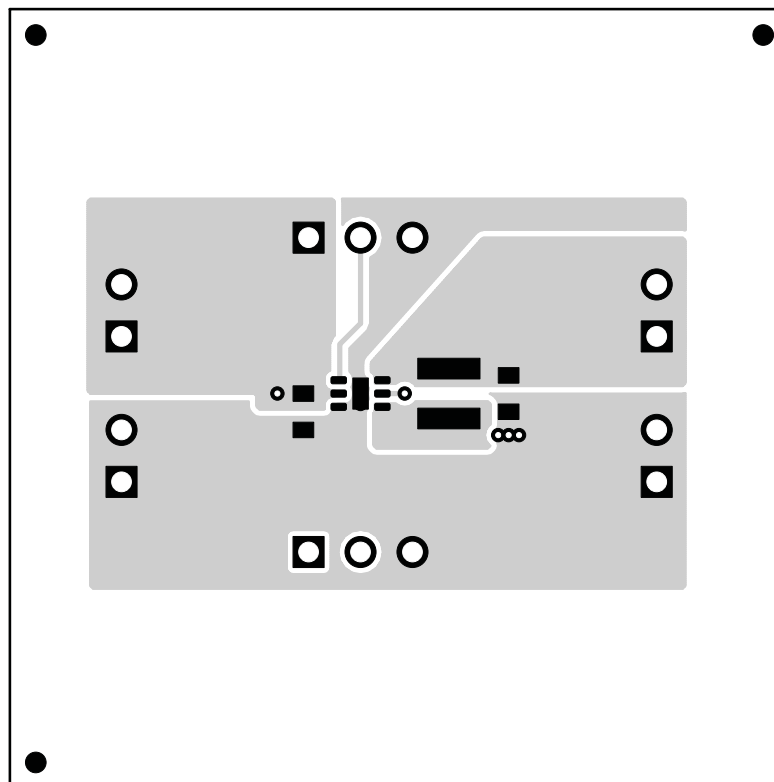

Figure 9. Top Layer Routing

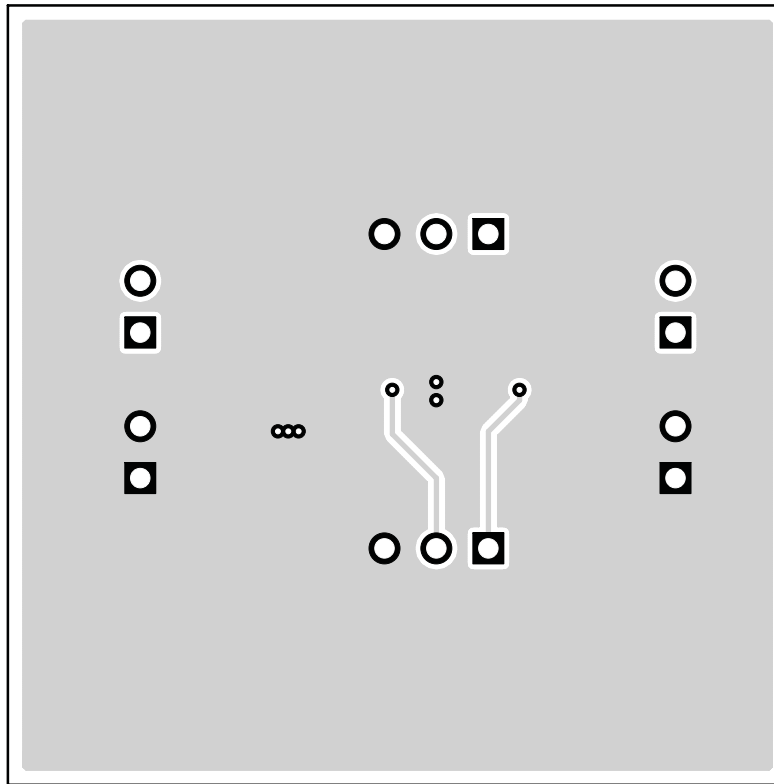
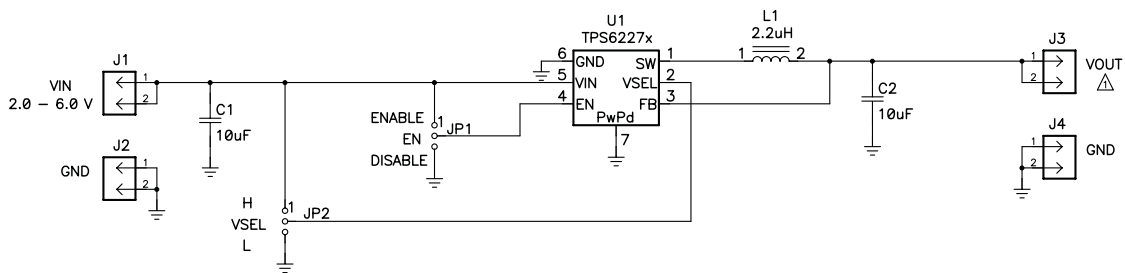

Figure 10. Bottom Layer Routing

6 Schematic and Bill of Materials

This section provides the TPS6227XEVM-306 schematic and bill of materials.

6.1 Schematic



△ See specific device datasheet for output voltage.

Figure 11. TPS6227XEVM-306 Schematic

6.2 Bill of Materials

Table 2. TPS6227xEVM-306 Bill of Materials⁽¹⁾⁽²⁾⁽³⁾⁽⁴⁾

Count	Reference Description	Value	Description	Size	Part Number	MFR
2	C1, C2	10 μ F	Capacitor, Ceramic, 6.3 V, X5R, 20%	0603	GRM188R60J106ME47D	muRata
4	J1, J2, J3, J4	PTC36SAAN	Header, 2 pin, 100 mil spacing, (36-pin strip)	0.100 x 2	PTC36SAAN	Sullins
2	JP1, JP2	PTC36SAAN	Header, 3 pin, 100mil spacing, (36-pin strip)	0.100 x 3	PTC36SAAN	Sullins
1	L1	2.2 μ H	Inductor, SMT, 1.5 A, 110 m Ω	0.118 x 0.118 inch	LPS3010-222ML	Coilcraft
1	U1	TPS62270DRV	IC, 2.25 MHz 400 mA Step-Down Converter w/ selectable VOUT	SON-6[DRV]	TPS62270DRV	TI
2	—	—	Shunt, 100-mil, Black	0.1	929950-00	3M
1	—	—	PCB	1.50 x 1.50 inch	HPA306	ANY

- (1) These assemblies are ESD sensitive, ESD precautions shall be observed.
(2) These assemblies must be clean and free from flux and all contaminants. Use of no clean flux is not acceptable.
(3) These assemblies must comply with workmanship standards IPC-A-610 Class 2.
(4) Reference designators marked with an asterisk (***) cannot be substituted. All other components can be substituted with equivalent manufacturer's components.

EVALUATION BOARD/KIT IMPORTANT NOTICE

Texas Instruments (TI) provides the enclosed product(s) under the following conditions:

This evaluation board/kit is intended for use for **ENGINEERING DEVELOPMENT, DEMONSTRATION, OR EVALUATION PURPOSES ONLY** and is not considered by TI to be a finished end-product fit for general consumer use. Persons handling the product(s) must have electronics training and observe good engineering practice standards. As such, the goods being provided are not intended to be complete in terms of required design-, marketing-, and/or manufacturing-related protective considerations, including product safety and environmental measures typically found in end products that incorporate such semiconductor components or circuit boards. This evaluation board/kit does not fall within the scope of the European Union directives regarding electromagnetic compatibility, restricted substances (RoHS), recycling (WEEE), FCC, CE or UL, and therefore may not meet the technical requirements of these directives or other related directives.

Should this evaluation board/kit not meet the specifications indicated in the User's Guide, the board/kit may be returned within 30 days from the date of delivery for a full refund. **THE FOREGOING WARRANTY IS THE EXCLUSIVE WARRANTY MADE BY SELLER TO BUYER AND IS IN LIEU OF ALL OTHER WARRANTIES, EXPRESSED, IMPLIED, OR STATUTORY, INCLUDING ANY WARRANTY OF MERCHANTABILITY OR FITNESS FOR ANY PARTICULAR PURPOSE.**

The user assumes all responsibility and liability for proper and safe handling of the goods. Further, the user indemnifies TI from all claims arising from the handling or use of the goods. Due to the open construction of the product, it is the user's responsibility to take any and all appropriate precautions with regard to electrostatic discharge.

EXCEPT TO THE EXTENT OF THE INDEMNITY SET FORTH ABOVE, NEITHER PARTY SHALL BE LIABLE TO THE OTHER FOR ANY INDIRECT, SPECIAL, INCIDENTAL, OR CONSEQUENTIAL DAMAGES.

TI currently deals with a variety of customers for products, and therefore our arrangement with the user **is not exclusive.**

TI assumes **no liability for applications assistance, customer product design, software performance, or infringement of patents or services described herein.**

Please read the User's Guide and, specifically, the Warnings and Restrictions notice in the User's Guide prior to handling the product. This notice contains important safety information about temperatures and voltages. For additional information on TI's environmental and/or safety programs, please contact the TI application engineer or visit www.ti.com/esh.

No license is granted under any patent right or other intellectual property right of TI covering or relating to any machine, process, or combination in which such TI products or services might be or are used.

FCC Warning

This evaluation board/kit is intended for use for **ENGINEERING DEVELOPMENT, DEMONSTRATION, OR EVALUATION PURPOSES ONLY** and is not considered by TI to be a finished end-product fit for general consumer use. It generates, uses, and can radiate radio frequency energy and has not been tested for compliance with the limits of computing devices pursuant to part 15 of FCC rules, which are designed to provide reasonable protection against radio frequency interference. Operation of this equipment in other environments may cause interference with radio communications, in which case the user at his own expense will be required to take whatever measures may be required to correct this interference.

Mailing Address: Texas Instruments, Post Office Box 655303, Dallas, Texas 75265
Copyright © 2008, Texas Instruments Incorporated

EVM WARNINGS AND RESTRICTIONS

It is important to operate this EVM within the input voltage range of 2.0 V to 6.0 V and the output voltage range of 0.6 V to 6.0 V.

Exceeding the specified input range may cause unexpected operation and/or irreversible damage to the EVM. If there are questions concerning the input range, please contact a TI field representative prior to connecting the input power.

Applying loads outside of the specified output range may result in unintended operation and/or possible permanent damage to the EVM. Please consult the EVM User's Guide prior to connecting any load to the EVM output. If there is uncertainty as to the load specification, please contact a TI field representative.

During normal operation, some circuit components may have case temperatures greater than 85°C. The EVM is designed to operate properly with certain components above 85°C as long as the input and output ranges are maintained. These components include but are not limited to linear regulators, switching transistors, pass transistors, and current sense resistors. These types of devices can be identified using the EVM schematic located in the EVM User's Guide. When placing measurement probes near these devices during operation, please be aware that these devices may be very warm to the touch.

Mailing Address: Texas Instruments, Post Office Box 655303, Dallas, Texas 75265
Copyright © 2008, Texas Instruments Incorporated

IMPORTANT NOTICE

Texas Instruments Incorporated and its subsidiaries (TI) reserve the right to make corrections, modifications, enhancements, improvements, and other changes to its products and services at any time and to discontinue any product or service without notice. Customers should obtain the latest relevant information before placing orders and should verify that such information is current and complete. All products are sold subject to TI's terms and conditions of sale supplied at the time of order acknowledgment.

TI warrants performance of its hardware products to the specifications applicable at the time of sale in accordance with TI's standard warranty. Testing and other quality control techniques are used to the extent TI deems necessary to support this warranty. Except where mandated by government requirements, testing of all parameters of each product is not necessarily performed.

TI assumes no liability for applications assistance or customer product design. Customers are responsible for their products and applications using TI components. To minimize the risks associated with customer products and applications, customers should provide adequate design and operating safeguards.

TI does not warrant or represent that any license, either express or implied, is granted under any TI patent right, copyright, mask work right, or other TI intellectual property right relating to any combination, machine, or process in which TI products or services are used. Information published by TI regarding third-party products or services does not constitute a license from TI to use such products or services or a warranty or endorsement thereof. Use of such information may require a license from a third party under the patents or other intellectual property of the third party, or a license from TI under the patents or other intellectual property of TI.

Reproduction of TI information in TI data books or data sheets is permissible only if reproduction is without alteration and is accompanied by all associated warranties, conditions, limitations, and notices. Reproduction of this information with alteration is an unfair and deceptive business practice. TI is not responsible or liable for such altered documentation. Information of third parties may be subject to additional restrictions.

Resale of TI products or services with statements different from or beyond the parameters stated by TI for that product or service voids all express and any implied warranties for the associated TI product or service and is an unfair and deceptive business practice. TI is not responsible or liable for any such statements.

TI products are not authorized for use in safety-critical applications (such as life support) where a failure of the TI product would reasonably be expected to cause severe personal injury or death, unless officers of the parties have executed an agreement specifically governing such use. Buyers represent that they have all necessary expertise in the safety and regulatory ramifications of their applications, and acknowledge and agree that they are solely responsible for all legal, regulatory and safety-related requirements concerning their products and any use of TI products in such safety-critical applications, notwithstanding any applications-related information or support that may be provided by TI. Further, Buyers must fully indemnify TI and its representatives against any damages arising out of the use of TI products in such safety-critical applications.

TI products are neither designed nor intended for use in military/aerospace applications or environments unless the TI products are specifically designated by TI as military-grade or "enhanced plastic." Only products designated by TI as military-grade meet military specifications. Buyers acknowledge and agree that any such use of TI products which TI has not designated as military-grade is solely at the Buyer's risk, and that they are solely responsible for compliance with all legal and regulatory requirements in connection with such use.

TI products are neither designed nor intended for use in automotive applications or environments unless the specific TI products are designated by TI as compliant with ISO/TS 16949 requirements. Buyers acknowledge and agree that, if they use any non-designated products in automotive applications, TI will not be responsible for any failure to meet such requirements.

Following are URLs where you can obtain information on other Texas Instruments products and application solutions:

Products

Amplifiers	amplifier.ti.com
Data Converters	dataconverter.ti.com
DSP	dsp.ti.com
Clocks and Timers	www.ti.com/clocks
Interface	interface.ti.com
Logic	logic.ti.com
Power Mgmt	power.ti.com
Microcontrollers	microcontroller.ti.com
RFID	www.ti-rfid.com
RF/IF and ZigBee® Solutions	www.ti.com/lprf

Applications

Audio	www.ti.com/audio
Automotive	www.ti.com/automotive
Broadband	www.ti.com/broadband
Digital Control	www.ti.com/digitalcontrol
Medical	www.ti.com/medical
Military	www.ti.com/military
Optical Networking	www.ti.com/opticalnetwork
Security	www.ti.com/security
Telephony	www.ti.com/telephony
Video & Imaging	www.ti.com/video
Wireless	www.ti.com/wireless

Mailing Address: Texas Instruments, Post Office Box 655303, Dallas, Texas 75265
Copyright © 2008, Texas Instruments Incorporated